

High Efficiency EC Direct Drive Fans (Standard) ECDDC 201-178 (7/7)

Technical Data

Supply (V/Ph/Hz)	230 / 1 / 50
Max Airflow (m³/h)	2414
Max Current (A)	2.44
Max Input Power (W)	540
Max Speed (rpm)	1559
ErP Efficiency Rating (FMEG)	49
Ip Rating	20
Motor Insulation Class	F
Temperature Range (°C)	-20 to +40
Weight (KG)	10.5

Performance Data

Data Point	Static Pressure (pa)	Airflow (m³/h)	Current (A)	Speed (rpm)	Power (W)
1	353	0.00	0.64	1556	121
2	314	516	0.79	1556	159
3	260	1533	1.64	1558	360
4	134	2182	2.42	1559	540
5	0.00	2414	2.44	1432	540

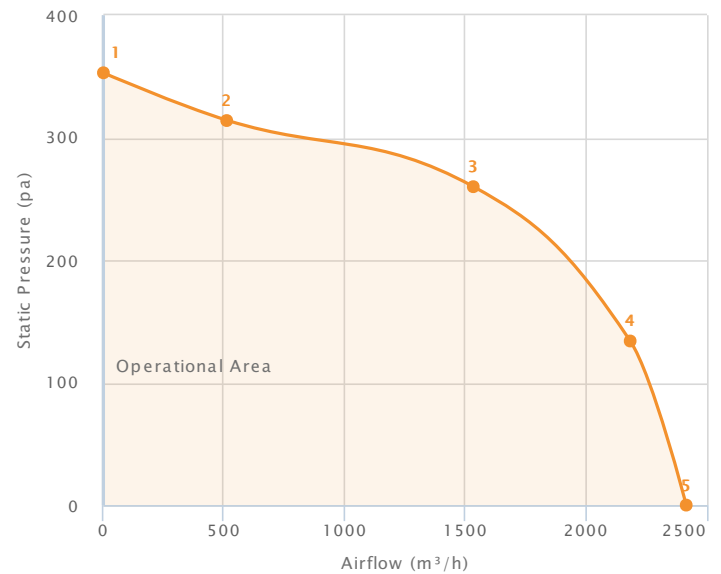

■ Tested in accordance with ISO 5801
■ Installation type method - type A

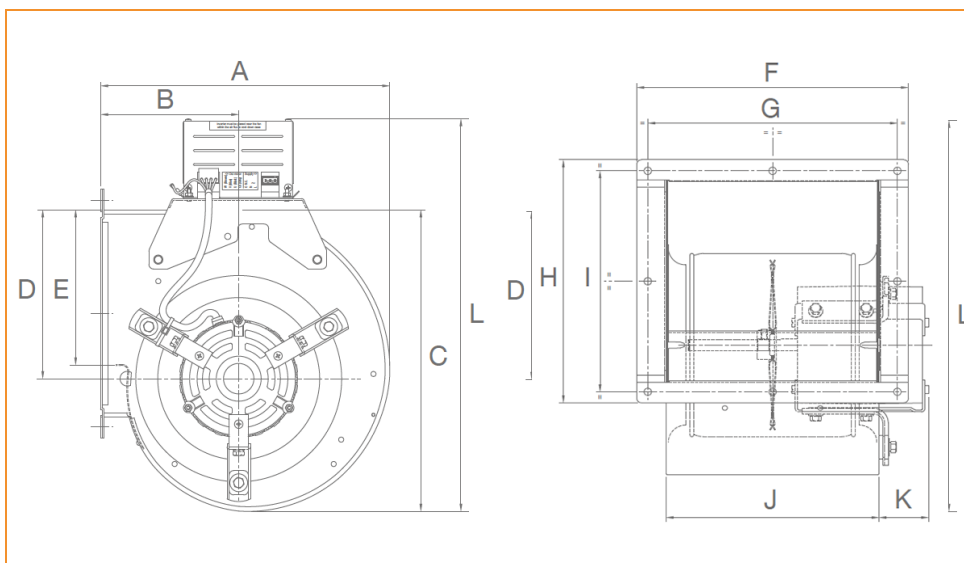

Dimensions

A	309	G	272
B	148	H	265
C	322	I	241
D	180	J	232
E	165	K	54
F	296	L	419

General Enquiries
+44 (0) 1793 524 291

Tech Support
+44 (0) 1793 524 291

Sales Support
+44 (0) 1793 640 554

www.torin-sifan.com

torin-sifan
The Partner of Choice